

Triac / Phase, 0-10V, 1-10V, Potentiometer, 10V PWM 5 in 1 dimming  
Electronic Dimmable LED driver 300W

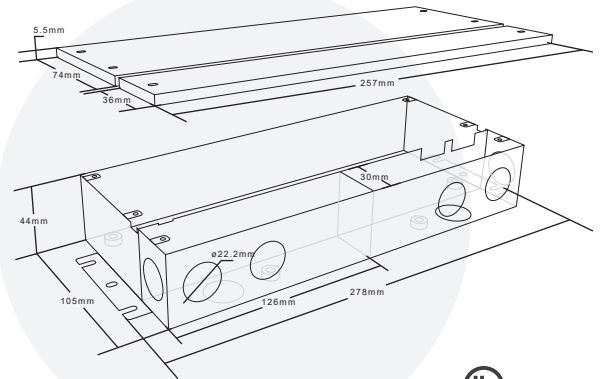

# G-97626



<b>OUTPUT</b>	DC VOLTAGE	24V
	VOLTAGE TOLERANCE	±0.5V
	VOLTAGE REGULATION	±0.5%
	RATED CURRENT	12.5A
	RATED POWER	300W
	LOAD REGULATION	±1%
<b>INPUT</b>	VOLTAGE RANGE	110-277 VAC
	FREQUENCY RANGE	47-63 Hz
	POWER FACTOR	0.99@ 120 VAC / 0.95@ 277 VAC
	THD	<20% @120 VAC & 227 VAC
	EFFICIENCY	88% @ 120 VAC / 82% @ 227VAC
	AC CURRENT	3.4A @ 100 VAC
	INRUSH CURRENT	35A, 50% 1.9MS @227VAC
	LEAKAGE CURRENT	<0.5mA
<b>PROTECTION</b>	VOLTAGE RANGE	SHUT DOWN O/P VOLTAGE, RE-POWER ON TO RECOVER AFTER FAULT CONDITION REMOVED
	FREQUENCY RANGE	≤120% CONSTANT CURRENT LIMITING, AUTO-RECOVERY
	POWER FACTOR	100°C ±10°C SHUT DOWN O/P VOLTAGE, AUTOMATICALLY RECOVER AFTER COOLING
<b>ENVIRONMENT</b>	WORKING TEMP	-40~+140°F (-40~60°C) °SEE BELOW DERATING CURVE
	WORKING HUMIDITY	20~95%RH, NON-CONDENSING
	STORAGE TEM., HUMIDITY	-40~+176°F (-40~80°C), 10~95%RH
	TEMP COEFFICIENT	±0.03% /°C (0~50°C)
	VIBRATION	10~500HZ, 5G 10 MIN/1 CYCLE, PERIOD FOR 60 MIN EACH ALONG X,Y,Z AXES
<b>SAFETY &amp; EMC</b>	SAFETY STANDARDS	UL8750, CAN/CSA-C22.2 No. 250.13
	WITHSTAND VOLTAGE	I/P - O/P: 1.8KVAC
	ISOLATION RESISTANCE	I/P - O/P: 100MΩ/500VDC/25°C/70%RH
	EMC EMISSION	FCC 47 CFR PART 15, SUBPART B
<b>PACK</b>	CASE	10 UNITS